

STATE OF FLORIDA  
DEPARTMENT OF TRANSPORTATION  
CENTRAL REFERENCE LIBRARY  
BURNS BUILDING  
TALLAHASSEE, FLORIDA 32301

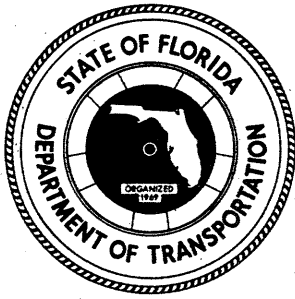

BEST MANAGEMENT PRACTICES

# 85-293

ENHANCED EROSION AND SEDIMENT

CONTROL USING SWALE BLOCKS

University of Central Florida  
Department of Civil Engineering and  
Environmental Sciences

Martin P. Wanielista

Y. A. Yousef

L. M. Van DeGroaff

S. H. Rehmann - Koo

FL-ER-35-87

BUREAU OF ENVIRONMENT

ENVIRONMENTAL RESEARCH

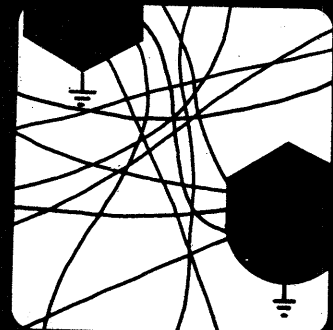
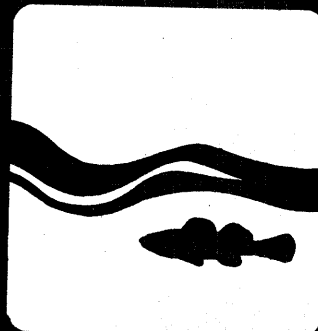

STATE OF FLORIDA  
 DEPARTMENT OF TRANSPORTATION  
 CENTRAL REFERENCE LIBRARY  
 BURNS BUILDING  
 TALLAHASSEE, FLORIDA 32301

Enhanced Erosion and Sediment Control  
 Wanielista

10909  
 010103



1/22/87 GMB:CRK 0.2

1. Report No. FL/DOT/BMR-85-293		5. Report Date September 1986	
4. Title and Subtitle BEST MANAGEMENT PRACTICES - ENHANCED EROSION AND SEDIMENT CONTROL USING SWALE BLOCKS		6. Performing Organization Code	
7. Author(s) M.P. Wanielista, Y.A. Yousef, L.M. Van DeGraaff and S.H. Rehmann-Koo		8. Performing Organization Report No.	
9. Performing Organization Name and Address University of Central Florida Civil Engineering and Environmental Sciences Dept. P.O. Box 25,000 Orlando, FL 32816-0993		10. Work Unit No. (TRAIS)	
12. Sponsoring Agency Name and Address FL Dept. of Transportation Bureau of Materials & Research P.O. Box 1029 Gainesville, FL 32602		11. Contract or Grant No. FLHPR Study E-11-81	
FL Dept. of Transportation Bureau of Environment 605 Suwannee St. M.S. 37 Tallahassee, FL 32301		13. Type of Report and Period Covered Final Report January 1982-September 1986	
15. Supplementary Notes Prepared in cooperation with the Federal Highway Administration		14. Sponsoring Agency Code	
16. Abstract <p>This report has as its focus erosion and sediment control of an existing highway using an innovative control concept, namely swale blocks.</p> <p>Swales are an important management practice for source control of rainfall excess (runoff volume) from highways. Inherent in the design is the specification that the swale wetted areas will infiltrate the rainfall excess. The swale design investigated in this work is one which will infiltrate the runoff from the first 3 inches (7.6 cm) of every storm event. When this removal is not achieved during flow through, swale blocks are suggested to retain the remaining waters.</p> <p>Swale blocks or filter berms were designed and constructed to illustrate operational effectiveness. Design aids were developed for various berm heights and highway slopes as a function of berm spacing for an Interstate highway section. Berms were constructed in swales along a four-lane roadway to determine hydraulic and sediment control effectiveness for a particular design.</p>			
Environment Erosion Sediment Best Management Practices Roadside Swales Highway Runoff		18. Distribution Statement No restrictions. This document is available to the public through the National Technical Information Service Springfield, VA 22161.	
19. Security Classif. (of this report) Unclassified	20. Security Classif. (of this page) Unclassified	21. No. of Pages 49	22. Price

1911  
1912  
1913  
1914  
1915  
1916  
1917  
1918  
1919  
1920  
1921  
1922  
1923  
1924  
1925  
1926  
1927  
1928  
1929  
1930  
1931  
1932  
1933  
1934  
1935  
1936  
1937  
1938  
1939  
1940  
1941  
1942  
1943  
1944  
1945  
1946  
1947  
1948  
1949  
1950  
1951  
1952  
1953  
1954  
1955  
1956  
1957  
1958  
1959  
1960  
1961  
1962  
1963  
1964  
1965  
1966  
1967  
1968  
1969  
1970  
1971  
1972  
1973  
1974  
1975  
1976  
1977  
1978  
1979  
1980  
1981  
1982  
1983  
1984  
1985  
1986  
1987  
1988  
1989  
1990  
1991  
1992  
1993  
1994  
1995  
1996  
1997  
1998  
1999  
2000  
2001  
2002  
2003  
2004  
2005  
2006  
2007  
2008  
2009  
2010  
2011  
2012  
2013  
2014  
2015  
2016  
2017  
2018  
2019  
2020  
2021  
2022  
2023  
2024  
2025

FINAL REPORT

on

**BEST MANAGEMENT PRACTICES - ENHANCED EROSION AND SEDIMENT  
CONTROL USING SWALE BLOCKS**

BY

M.P. Wanielista, Y.A. Yousef, L.M. Van DeGraaff  
and S.H. Rehmann-Koo

Civil Engineering and Environmental Sciences Department  
College of Engineering, University of Central Florida  
Orlando, FL 32816-0993

Submitted to

FLORIDA DEPARTMENT OF TRANSPORTATION  
Tallahassee, Florida  
Contract No. 99700-7271

September 1986

PROJECT OFFICER:

Win Lindeman  
Haydon Burns Building  
605 Suwannee Street  
Tallahassee, FL 32301

## ACKNOWLEDGEMENTS

The authors wish to acknowledge with gratitude the financial support and technical assistance given by FDOT and FHWA personnel. The interest and assistance of Messrs. Gary Evink, Win Lindeman, Ken Weldon and Grover Rivers from FDOT; and Byron Lord from FHWA are very much appreciated. Without their support this study would not have been possible.

The authors are deeply indebted for support and assistance given to them by the students, faculty and administration from the Engineering and Industrial Experiment Station at the College of Engineering, University of Central Florida. They helped in every way to make our job easier, and we sincerely appreciate it.

## ABBREVIATIONS AND CONVERSION FACTORS

[Factors for converting inch-pound units to International System of units (SI) and abbreviation of units]

<u>Multiply</u>	<u>By</u>	<u>To Obtain</u>
inch (in)	25.4	millimeter (mm)
foot (ft)	0.3048	meter (m)
acre	0.4047	hectare (ha)
cubic foot per second (ft <sup>3</sup> /s)	0.02832	cubic meter per second (m <sup>3</sup> /s)
square foot (ft <sup>2</sup> )	0.09290	square meter (m <sup>2</sup> )
pound (lb)	0.4536	kilogram (kg)
cubic foot (ft <sup>3</sup> )	0.02832	cubic meter (m <sup>3</sup> )

### NOTICE

The contents of this report reflect the views of the authors who are responsible for the facts and the accuracy of the data presented herein. The contents do not necessarily reflect the official views or policies of the Federal Highway Administration. This report does not constitute a standard, specification, or regulation.

Neither the State of Florida nor the United States Government endorse products or manufacturers. Trade or manufacturers names appears herein only because they are considered essential to the object of this report.

## TABLE OF CONTENTS

	<u>Page</u>
CHAPTER I - INTRODUCTION . . . . .	1
Scope . . . . .	2
CHAPTER II - EROSION AND SEDIMENT CONTROL . . . . .	3
Erosion Potential . . . . .	3
Efficiency of Erosion Control . . . . .	7
Sediment . . . . .	9
Sediment Control . . . . .	11
Efficiency of Sediment Control . . . . .	14
Maintenance and Operation . . . . .	16
Summary . . . . .	17
CHAPTER III - SWALE HYDROLOGY, HYDRAULICS AND DESIGN . . . . .	19
Design Criteria and Procedures . . . . .	19
Theory . . . . .	20
Field Experimentation . . . . .	22
Runoff Coefficients . . . . .	23
Roughness Coefficient . . . . .	25
Swale Blocks . . . . .	26
Example Problem . . . . .	28
Summary . . . . .	31
CHAPTER IV - SWALE BLOCK PERFORMANCE . . . . .	32
Introduction . . . . .	32
Description of Swale System . . . . .	32
Design of the Example Swale System . . . . .	35
Swale Block (A) . . . . .	37
Swale Block (B), (C), and (D) . . . . .	37
Field Data . . . . .	38
Rainfall Volume . . . . .	38
Runoff Volume and Suspended Solids . . . . .	39
Summary . . . . .	42
CHAPTER V - SUMMARY, CONCLUSIONS AND RECOMMENDATIONS . . . . .	43
REFERENCES . . . . .	46

LIST OF TABLES

<u>Table</u>	<u>Page</u>
1 Typical Erosion Control Potential Values (VM) . . . . .	5
2 Control Methods/Removal Effectiveness - Operating Highways . . .	8
3 Concentration and Loadings of Highway Runoff . . . . .	10
4 Sediment Control/Removal Effectiveness - Operating Highways . . .	16
5 Hydrograph Characteristics of Swale Experiments . . . . .	24
6 Hydraulic Characteristics of Swale Experiments . . . . .	24
7 Required Storage Volume for Two Watershed Infiltration Rates Using a 1" and 3" Volume of Rainfall . . . . .	27
8 Subwatershed Areas . . . . .	35
9 Land Use For Each Subwatershed . . . . .	36
10 SCS Soil Classification And Percentage Of Each Soil Type . . . . .	36
11 Storage Volumes For Swale Blocks (B), (C), and (D) . . . . .	38
12 Runoff Volume Between Swale Blocks . . . . .	40
13 Rainfall (Inches) And Average Total Suspended Solids Concentrations (mg/L) For Various Storm Events . . . . .	40



LIST OF FIGURES

<u>Figure</u>		<u>Page</u>
1	System Diagram of Pollutational Inputs/Outputs To and From the Road Surface . . . . .	12
2	Schematic Diagrams for Hydraulic Design of Swales . . . . .	21
3	Berm Spacing ( $\ell$ ) as a Function of Berm Heights ( $H, h$ ) and slope ( $s$ ) for Swale of Side Slope of 6 on 1 . . . . .	29
4	Site Plan . . . . .	33
5	Swale Block Details . . . . .	34

## CHAPTER I

### INTRODUCTION

The concern for improved water quality control through reduction in erosion and sediment transport is an important aspect of highway operation. Erosion is the process of removing surface materials which when entrained in water become sediment. Sediment is then transported from the erosion site to another location. By reducing water velocity and volume from a site, erosion and sediment reductions can be partly achieved.

The quality of receiving water bodies has possibly deteriorated in part due to uncontrolled discharges of sediment. Methods have been developed to reduce the quantity of stormwater and associated sediments by re-routing runoff waters into stormwater management facilities. This report presents results of work on modifying the design to improve the effectiveness of one of these stormwater facilities, namely swales. By definition, swales are vegetation-covered open channels which transport and infiltrate some of the runoff waters. Swales have been primarily successful in flood control by reducing peak discharges and acting as equalization basins. By reducing the velocity of flow in a swale, infiltration and sedimentation may be increased. Thus, the concept of pooling water in a swale by means of a swale block was initiated.

Currently in Florida, swales used for stormwater water quality control are designed to hold the runoff from the three year frequency, one hour duration rainfall event. Considering many years of rainfall data and one hour duration storms, the maximum volume of rainfall associated with the time duration and the frequency of occurrence can be estimated. However, this volume most likely will be exceeded more than once every three years because other duration storms are present and must be considered. Also for

the same storm duration time, it is possible that the volume associated with the three year frequency will be exceeded. Using data from 15 hourly rainfall stations in Florida, there is approximately one 3 inch (7.6 cm) or greater rainfall event for every 100 storms. There are approximately 125 storms per year. The volume used for the example calculations of this report is three (3) inches (7.6 cm). This volume is the approximate maximum for the State of Florida.

Highway runoff transports sediment and various chemical forms such as heavy metals, oils, greases and nutrients. Possibly this water can be conveniently stored in swale areas. Thus it seems logical that this is the place where sediment and other chemical reductions can occur. The use of swale blocks for increased sediment reduction and flood control would add to the value of these facilities.

#### SCOPE

The scope is limited to erosion control and sediment retention from operating highways and to development of swale blocks as sediment control systems. Since swales are vegetated open channels, the vegetation cover reduces erosion.

This is the second of a series of reports leading to a procedure for the design of Best Management Practices (BMP's) for highway runoff. The first was published in 1985 (Yousef, et al.). Focus for this report is the hydrologic design of swale blocks and an examination of the sediment retention effectiveness of actual operational swale blocks. The purpose of these findings is to aid in the design of swale blocks operating adjacent to highways. Specific results can be used to develop design procedures which will assist in swale block sizing and spacing.

## CHAPTER II

### EROSION AND SEDIMENT CONTROL

Soil erosion is essentially the detachment and relocation of soil particles through the dynamic action of water or wind. Soil exposure inevitably accelerates the erosion process because of the removal of the protective soil cover. A reduction in the rate of erosion is achieved by controlling the vulnerability of the soil to the erosion process.

Soil particles become sediment when they are detached and moved from their initial resting place. Even with the best erosion control practices, some sediment will be generated. Deposits of sediment in a stormwater conveyance system reduces the hydraulic capacity of the system and can destroy aquatic habitats. Increased turbidity will reduce light penetration and, possibly alter the ecological balance of receiving waters. The colloidal fraction of suspended sediment is capable of adsorbing nutrients, pesticides, heavy metals and organics. Eutrophication in many fresh water systems is caused by discharging runoff carrying nutrients adsorbed to soil particles.

#### EROSION POTENTIAL

A combination of climate, vegetative cover, land use, soil properties, topography, and erosion control methods determines the erosion potential. The universal soil loss equation (Agricultural Research Service, 1961) was developed to estimate water soil loss potential. Israelsen, et al, in a National Cooperative Highway Research Program Report (1980) modified the universal soil loss equation to serve as a basis for estimating water soil loss potential. They conducted extensive controlled testing using a number

of control methods. The modified soil loss equation is:

$$A = (R)(K)(LS)(VM) \quad (1)$$

where

- A = computed amount of soil loss per unit area and time interval of study (generally expressed as tons/ac-yr)
- R = rainfall energy factor
- K = soil erodibility factor (tons/acre-year per unit of R)
- LS = topographic factor, length and steepness of slope (dimensionless)
- VM = erosion control factor (dimensionless)

Each factor in the equation has to be determined from site specific conditions. Rainfall energy and control methods have the greatest effects on the sediment yield. The rainfall energy factor is reported to vary in the United States from a low value of 20 in the Northwestern area to a high of 350 in Florida and some other Gulf State areas.

Vegetative covers were identified by Israelson (1980) and are being specified as one of the more effective erosion and sediment control methods by State Departments of Transportation (Florida, 1985, North Carolina, 1972, Minnesota, 1970, etc.). Vegetative covers protect the soil from rain impact and prevent the removal of soil particles. They also reduce the velocity of the runoff and increase soil storage. Table 1 indicates the relative erosion control potential of vegetative covers and other methods more appropriate to construction activities. From Table 1 it is noted that vegetative covers can be very effective in the control of erosion.

Once established, vegetation requires a minimal amount of maintenance, with a possible need for selective sodding and seeding of small areas. Generally, slopes upon which vegetation can be satisfactorily established and maintained cannot exceed 50 percent. However, optimum vegetative stability requires slopes of 25 percent or less. The maximum slope steepness is a function of the structure and composition of the soil and the moisture content. Vegetative covers have been shown to be the most

effective soil stabilizers. The cover shields the ground and its roots bind and secure the soil particles. Permanent vegetative stabilization is accomplished by the proper selection and planting of grasses, legumes, shrubs and trees. The type and mixture of plant species will depend on the seasonal mixture and environmental exposure. Before planting a crop, the topsoil should be treated with fertilizer, and the pH of the soil should be between 5 and 7 (Florida DOT, 1982).

TABLE 1 Typical Erosion Control Potential Values (VM)  
(adopted from Israelsen, 1980)

<u>Condition</u>	<u>VM (Fraction)</u>
1. <u>Bare Soil Conditions</u>	
freshly disked to 6-8 inches	1.00
after one rain	0.89
loose to 12 inches smooth	0.90
loose to 12 inches rough	0.80
compacted bulldozer scraped up and down	1.30
same except root raked	1.20
compacted bulldozer scraped across slope	1.20
same except root raked across	0.90
rough irregular tracked all directions	0.90
seed and fertilize, fresh	0.64
same after six months	0.54
2. <u>Asphalt Emulsion on Bare Soil</u>	<u>Range</u>
1250 gallons/acre	
1210 gallons/acre	0.01-0.019
605 gallons/acre	0.14-0.57
302 gallons/acre	0.28-0.60
151 gallons/acre	0.65-0.70
3. <u>Dust Binder</u>	
605 gallons/acre	1.05
1210 gallons/acre	0.29-0.78
4. <u>Other Chemicals</u>	
1000 lb. fiber Glass Roving with 60-150 gallons asphalt emulsion/acre	0.01-0.05
Aquatain	0.68
Aerospray 70, 10 percent cover	0.94
Curasol AE	0.30-0.48
Petroset SB	0.40-0.66
Portland cement + Latex	
1000 lbs/ac + 8 gals/ac	0.13
1500 lbs/ac + 12 gals/ac	0.006
5. <u>Vegetative Cover</u>	
temporary, 0 to 60 days	0.40
temporary, after 60 days	0.05
permanent, 0 to 60 days	0.40
permanent, 2 to 12 months	0.05
permanent, after 12 months	0.01

For best results after seeding, the surface should be mulched. Mulch treatments serve to absorb the impact of rainfall, help isolate the soil surface, and retain the soil moisture, which encourages faster germination of seedlings. Many materials may be used as mulch, including straw and sawdust. Chemical stabilizers may be used instead of mulch or in conjunction with mulch material. The composition of chemical stabilizers varies from asphalt emulsion to a latex. Areas treated with such soil binders show increased soil cohesion, but reduced permeability. Thus, runoff volume control may not be achieved.

Blanket products or nettings serve the same purpose as mulch, and are more difficult to disturb. Most blanket products consist of a type of netting that is interwoven with a mulch material incorporated in the webbing. Blankets are supplied in rolls and are applied in overlapping strips down the slope and attached to the ground with pegs or staples.

The erosion potential of soil particles also depends on the structure and texture, organic and moisture content, and permeability of the soil. Sandy soils are more permeable and allow water to infiltrate. Silts and clays are often quite cohesive and resist erosion, but when in suspension, are most difficult to settle out.

The topographic considerations include the slope steepness and length. Steeper slopes increase the runoff velocity and erosion potential. Long slopes show higher erosion than shorter slopes with the same steepness. Diseker et al. (1967) investigated bank slopes consisting of clay soils and found that flatter slopes show substantially less erosion than steeper slopes.

## EFFICIENCY OF EROSION CONTROL

Enhanced erosion control methods for retaining sediment are necessary in some areas. If erosion (removal of surface materials) can be reduced by a fractional amount, then efficiencies of erosion control can be estimated. Average annual reduction of potential sediment loss due to erosion can be estimated using the modified universal soil loss equation.

Reed (1978) reported some sediment reduction in terms of percent effectiveness. Rock dams were reported to obtain a trapping efficiency for both suspended and bed loads of approximately 5 percent, while seeding and mulching reduced erosion by 20 percent and straw bales placed around drainage inlets reduced sediment loads by 10 percent. The erosion control (seeding and mulching) was more effective than the sediment controls (rock dams and straw bales). Using the efficiencies reported by Reed and those efficiencies calculated from the "VM" factors of Israelsen, a comparison of erosion control effectiveness is developed. Calculations of sediment yield from an unprotected shoulder area adjacent to a highway depend on the slope and width (slope-length factor) of the shoulder, rainfall intensity factors and soil texture. Using a range of values as given in Table 2, unprotected shoulder areas are estimated to have a potential to erode between 26.6 and 322 tons of sediment per acre per year. These losses assume conditions which are more common to the Florida and Gulf-coast environment, such as a high rainfall energy factor and soil conditions. For soils from 78 roadside areas in the State of Florida Busey (1977) determined that silt was present in 76 of the samples and the average percentage of silt in a sample was 5.2. Also, clay was present in all but one sample and the average percentage in a sample was 5.4. The maximum percentages for silt and clay were 23.4 and 47.6 respectively. The range of K values used for



Table 2 reflects the Florida extremes to be expected as reported previously (Busey, 1977). For any site specific condition, more accurate estimates can be made. In Table 2 the relative effectiveness of the erosion control methods is shown. Sodding is shown to be the most effective method.

TABLE 2 Control Methods/Removal Effectiveness  
Operating Highways

Control Methods	Effectiveness Relative to Bare Ground (1.0-VM)	Reference	Mass Retained/Year Range dependent on K and LS*	
			Ton/Ac	1000 Kg/Ha
Rock Dams	0.05	Reed, 1978	1.33-16.1	2.98-36.1
Straw Bales	0.10	Reed, 1978	2.66-32.2	5.96-72.1
Seeding & Mulching	0.20	Reed, 1978	5.32-64.4	11.9-144.3
Vegetative Covers Temp after 60 days	0.95	Israelsen 1980	25.3-306	56.7-685
Sodding	0.99	Israelsen 1980	26.3-319	58.9-715
Maximum Potential Control	1.00		26.6-322	59.7-721

\*Assumed highway shoulder conditions are:

R = 350, for Florida (Wanielista, 1979)

K = .10 to .42, 2% organic loamy sand to 2% organic silty loam

LS = 0.76 to 2.19, 8% slope to 16% slope on a 60 foot slope length (Wanielista, 1979)

Example calculation for sodding:

$$\begin{aligned} \text{Estimated Minimum: Mass retained} &= (R)(K)(LS)(1 - VM) \\ &= 350(.10)(.76)(.99) \\ &= 26.3 \text{ tons/ac-yr } (58.9 \times 10^3 \text{ kg/ha}) \end{aligned}$$

$$\begin{aligned} \text{and Estimated Maximum: Mass retained} &= 350(.42)(2.19)(.99) \\ &= 319 \text{ tons/ac-yr } (715 \times 10^3 \text{ kg/ha}) \end{aligned}$$

## SEDIMENT

The problem of sediment transport starts when eroded material is removed from the point of origin and is carried away to a different location. Surface runoff is the prime mover of detached soil particles. The sediment load transported by the runoff consists of wash load, suspended sediment load and bed load. The wash load consists of very fine, or colloidal (silt and clay) particles, which settle very slowly. The suspended sediment is composed of soil particles carried and supported by the water itself. Bed load sediment refers to coarser particles, which move by rolling, sliding or bouncing along the stream bed. Sediment transportation and deposition is influenced by the flow characteristics of the water and the nature of the particles transported. As the velocity and turbulence increase, the water is able to transport more sediment; and as the velocity decreases, deposition of sediment occurs.

Sediment can be categorized as organic and inorganic material, where organic material may exist in various states of decomposition. Both the organic and inorganic fraction of natural sediment have been shown to adsorb chemical constituents on the solid surfaces, where the colloidal fraction has been found to be the most reactive (Stumm and Morgan, 1981). Clay particles often are negatively charged. Therefore, they adsorb positively charged ions on their surfaces, such as metals, nutrients and organic constituents. These complexes can exist in suspension or settle to the stream and lake bottoms. Some changes in environmental conditions can cause pollutants in the sediments to be released back to the water column. Organic compounds in stormwater can include oxygen consuming material.

The concentration of suspended sediment in streams can relate to the concentration of several water pollution constituents. Increases in

constituent concentrations during periods of stormwater runoff have been shown to be directly associated with increases in suspended sediment concentration (Burton, 1975).

Kobriger, et al. (1981) analyzed highway runoff, performing more than one thousand chemical analyses to develop regression curves for various constituents. The carrier pollutant used was total solids. Good correlation was shown to exist between total solids and sixteen commonly used water quality parameters. Because of these interactions of solids with other pollutants, sediment is an important parameter to consider when assessing surface water quality.

Gupta (1981) completed a constituent study which identified chemical and sediment levels in highway runoff during operating conditions. A summary of concentrations and loadings for sediment per storm event is shown in Table 3.

TABLE 3 Concentration and Loadings of Highway Runoff\*

Location	Suspended Solids		
	Concentrations (mg/L)	Event Loadings (lb/ac)	(kg/ha)
Hwy 794-Milw	268	19.6	22.0
Hwy 45-Milw	445	18.6	20.8
Grassy Site-Milw	303	7.8	8.7
Harrisburg	53	4.7	5.3
Nashville	209	14.0	15.7
Denver	259	13.7	15.3
Average	256	13.1	14.7

\*from Gupta (1981)

The amount and composition of contaminants on street surfaces is influenced by many factors some of which are the type and condition of street surface, land use, traffic volume, type of maintenance, etc. The accumulation rate of pollutants on the street surface is affected by deposition and removal rate. Sartor and Boyd (1972) stated that the quantity of contaminant material found at a given test site was dependent on the length and time between cleaning activities either by mechanical means or by rainfall; and streets considered in poor to fair pavement condition have loadings about 2.5 times greater than streets in good-to-excellent conditions. Gupta et al. (1981) found asphalt streets to have loadings up to 80 percent heavier than concrete streets. Most of these loadings are then removed in a rainfall event rather than by mechanical sweeping. The removal rate depends on antecedent dry conditions, rainfall intensity, traffic conditions and other source contributions.

Reinertsen (1981) analyzed sidewalks, roadways, and parking lots for mean surface concentrations of solids, COD, and lead, finding the highest pollutant deposits on sidewalks, followed by busy roadways and parking lots. Sources of these pollutants are illustrated in Figure 1. Note that the design of highway stormwater systems has little or no control of the sources. However, stormwater management of the runoff waters is under the control of the designers.

#### SEDIMENT CONTROL

Sediment control involves the retaining of transported sediment from highway impervious surfaces and contributing adjacent lands. Wanielista (1977) completed a field sampling program which included measures of

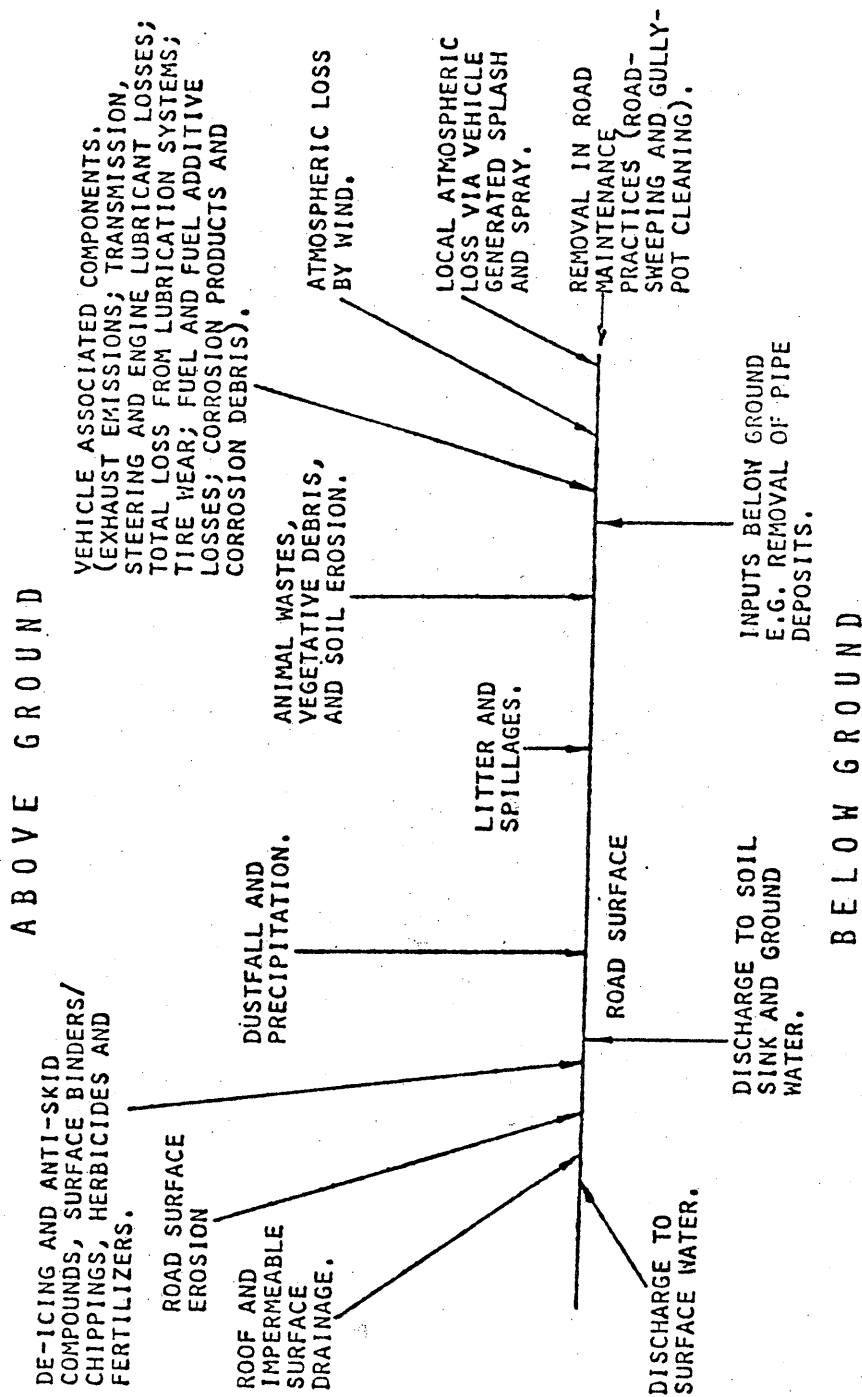

Figure 1 SYSTEM DIAGRAM OF POLLUTIONAL INPUTS/OUTPUTS TO AND FROM THE ROAD SURFACE

Source: Harrop, 1983

suspended solids for 14 off-line (diversion) retention sites in the Orlando, Florida area. Ten of these sites had runoff from highway or parking lot areas. Using field collected data on suspended solids for a 4 acre parking lot; the retention efficiencies per storm event for these off-line structures were found to vary from 64 percent to 100 percent if 1/4 inch (0.64 cm) of every runoff volume were diverted for treatment. When 1/2 inch (1.3 cm) capacity was provided, the efficiency range was from 92 percent to 100 percent per storm event. The retention efficiency was estimated by determining the pollutant mass at the inflow and at the outflow. This small watershed exhibited a first flush effect and this diversion produced very high retention effectiveness. On an average annual basis, using all the field collected data from all watersheds, the percent effectiveness on an average annual basis was calculated as about 80 percent for 1/4 inch (0.64 cm) treatment and 90 percent for 1/2 inch (1.3 cm) treatment volumes.

For a land use that was a mixture of highway pavement, residential and commercial areas, Oliver et al. (1981) examined the operation of a detention system. The average residence time was 28 days and the reported suspended solids removal efficiency was 88 percent. The East Central Florida Regional Planning Council (1983) reported an 85 percent efficiency for similar designed systems.

Shallow-water roadside ditches were examined to determine the fate of solids, bacteria, oils, metals, and nutrients from highway runoff (Wanielista, 1978). This study indicated that most of the sediment could be retained in the ditches with a very small fraction in the water column.

Field studies by Yousef et al. (1985) on swales showed that infiltration of runoff waters in swales was directly related to efficiency.

Thus if the runoff waters can be retained for infiltration in the swale, efficiency would increase proportional to the amount of water infiltrated. Kent et al. (1983) presented a methodology for incorporating soil storage into the design of on-site drainage (swale) systems. They projected a decrease in the size of detention ponds when vegetation and soil storage were considered in design. However, no suggestions were made for the hydrologic design of swales. No data were reported on sediment retention effectiveness. A possible modification of a swale for sediment control is to add a check dam to either contain or filter the runoff water before discharge. The check dam is called a swale block.

#### EFFICIENCY OF SEDIMENT CONTROL

Sediment can be retained in detention ponds, off-line retention ponds, filters, swales, and can be controlled by other less commonly used stormwater management methods. However, most data collected relates to non-highway conditions. The efficiencies of swales and swale blocks have seldom been reported in literature (Yousef, 1985).

Other preliminary work in a laboratory on efficiencies of swale blocks that both store and infiltrate runoff waters has been completed (Wanielista et al. 1982). It was noted that removal efficiencies were dependent on flow rates, such that the lower flows gave a greater reduction for some of the water quality parameters. Solids reduction as high as 90-99 percent were observed using a filter composed of building sand and alum sludge. Harper et al. (1982) extrapolated these results and designed filters for the Lake Eola Watersheds in Orlando, Florida. He observed a phosphorus removal efficiency of about 75% for a filter composed of alum sludge and sand that was 15 inches (38 cm) deep. Sediment removal was about 95

percent. The filter material replacement was estimated to be once every two years. Thus, maintenance time and costs will be significant. Because of this maintenance activity, these filters are rarely used. Hickok (1980) showed that an organic rich soil was capable of removing mainly phosphorus and nitrogen forms from stormwater. Another study with intermittent sand filters by Otis (1982) found ortho- and total phosphorus removals of 50 percent. Also, it was found that mixing the sand with calcium, aluminum, or iron species could improve removals up to 70 to 90 percent. This particular study was with filters which were 2 to 3 feet deep (0.6-0.92 m), and of "granular materials" underlain with collection drains. The disadvantage of using the sand was that the sorption sites were quickly covered with biological film, and thus, had to be replaced more often. The filter concept can be applied to swale blocks. Each block can be designed to retain and filter stormwater to achieve sediment removals. However, from a maintenance viewpoint, it is advisable to design the swale block to store water for infiltration through the swale bottom rather than through the block.

The efficiencies reported in Table 4 are believed to be a reasonable assessment for practices excluding swales since they relate to watersheds with highways. The development of the numbers of pounds per acre per event retained assumes the average discharge data from Table 3. Data for swales are non-existent, and at this time, a comparison is not available. However, if the swale block can achieve similar efficiencies at lower cost or need less maintenance, then the swale block would be a candidate for control of sediment.



TABLE 4 Sediment Control/Removal Effectiveness  
Operating Highways

Sediment Control Methods	Effectiveness (Relative to no control)	Event Retained Suspended Solids*		Reference
		(lbs/ac)	(kg/ha)	
Detention Pond (28 days average detention)	88	11.5	12.9	Oliver, 1981
Off-line Retention 1/4" diversion	80	10.5	11.8	Wanielista, 1977
1/2" diversion	90	11.8	13.2	Wanielista, 1977
Filters	95	12.5	14.0	Harper, 1982
On-line Retention (no discharge for rainfall less than 3 inches)	99	13.0	14.6	Wanielista, 1979
Maximum Possible Retained	100	13.1	14.7	Table 3

\*use of average values

#### MAINTENANCE AND OPERATION

All sediment and erosion control practices need routine inspection and maintenance. Whether the practice is vegetative or structural, minimum maintenance schedules must be implemented to ensure proper functioning. For retention ponds and other sediment accumulating devices, a most important activity is the timely cleanout and disposal of the accumulated deposits. Experiences in this research indicates that semi-annual inspection is necessary. The inspection frequency can be modified after a few years.

The removal of accumulated sediment from swales and detention/retention facilities should be carefully evaluated as to the method or combination of methods to accomplish sediment removal in an efficient and

economical way, while minimizing surrounding disturbances which could cause erosion. Some conventional sediment removal devices include a dragline, dredge, front-end loader, crane, dozer, shovel, or a vacuum device. Sediment disposal is an integral part of the sediment removal program. Retained material dumped and piled near the drainage structure can likely re-enter the surface drainage system during storm events and thus become a pollutant again. Sediments can be disposed of properly behind protective berms, buried or stockpiled, de-watered and properly vegetated. Vegetative practices require periodic inspection, cutting of the grass cover and shrubs, replacement of dead plants and re-seeding or other methods to re-establish a vegetative cover for bare areas. Roadway maintenance is important and routine work should include sediment removal, litter and refuse collection, drainage structure and culvert cleaning and erosion protection.

#### SUMMARY

Past research indicates that vegetation cover is effective for erosion control and there are three primary methods to control sediment in stormwater systems. One method is to design retention/detention systems with adequate holding time to allow settling of sediments. However, they may require a large area, which could be costly. The second method uses overland flow with infiltration. Areas adjacent to highways are sometimes used. The third alternative proposed here is to use swale blocks to infiltrate waters. This technique has been examined and its efficiencies have been shown to relate to infiltration (Yousef et al. 1985). The type of soil that works best for infiltration is one which has a variety of natural characteristics, such as silt, clay, organic matter, aluminum,

iron, and calcium, and a high permeability rate through the soil. Infiltration volume can be increased if the stormwaters can be stored between swale blocks to be constructed along the entire length of the swale.

### CHAPTER III

## SWALE HYDROLOGY AND HYDRAULICS

Swales and swale blocks can be used for erosion and sediment control. But, how effective are they for the reduction of runoff volume and flow rates? A swale is a vegetated open channel primarily designed to transport and infiltrate stormwaters. Since it is vegetated, it will have minimum erosion potential. The volume of runoff water that will infiltrate increases when the retention time increases. Thus, swale blocks constructed perpendicular to the swale flow line are useful to pond stormwaters. Use of swales and swale blocks decrease end-of-swale discharge volume and flow rates. In some cases these blocks eliminate or reduce the need for land acquisition outside of highway right-of-ways to store highway runoff. In this chapter, swale hydrology and hydraulics are examined using two sites adjacent to an interstate highway and a procedure for evaluation of a design is suggested.

### DESIGN CRITERIA AND PROCEDURES

A swale must be designed to infiltrate. The infiltration volume is a function of soil-water contact time which in turn is a function of slope, distance traveled, flow rate, depth of flow and the soil water holding capacity. In addition, the wetted area affects the volume of infiltrate given a known infiltration rate. If the first 3 inches of the runoff can be stored in the swale and allowed to infiltrate over a period of time during and immediately following a storm event, then stormwaters from 99 percent of the storm events in Florida will be infiltrated. This statement

assumes the stored water will infiltrate before the next storm. The design criteria specified here is to store the runoff from a 3 inch (7.6 cm) storm event. Using rainfall volume data for the State of Florida, Anderson (1982) determined that approximately one percent of the rainfall volumes were greater than three inches. Since there are about 125 storm events/year, there are on the average one or two storms per year with three inches or more of rainfall. Using daily rainfall volumes for the Orlando, Florida area, Walsh (1985) predicted 1.19 events per year with a 3 inch (7.6 cm) volume or more. He used twenty years of data.

## THEORY

Knowing watershed characteristics and a design storm for a particular area, an estimate can be made of rainfall excess (runoff) for that watershed. If it must be infiltrated, two simplified design conditions can be specified, namely provide an area large enough to infiltrate the rainfall excess, or provide a transport area to infiltrate some of the rainfall excess and another area to store and infiltrate that portion which has not been infiltrated during transport. Figure 2 illustrates these concepts. The watershed cumulative volume would be rainfall excess. Swale volume would be that remaining after swale transport. The major problem is to estimate the infiltration in the swale so as to reduce required storage at the end of the swale or to provide swale blocks to store the water in the swale. In equation form, a mathematical translation of rainfall to runoff can be done, such as illustrated in equation 2.

$$R = cP \quad (2)$$

where

- R = rainfall excess volume (depth)
- c = watershed runoff coefficient (dimensionless)
- P = rainfall volume (depth)

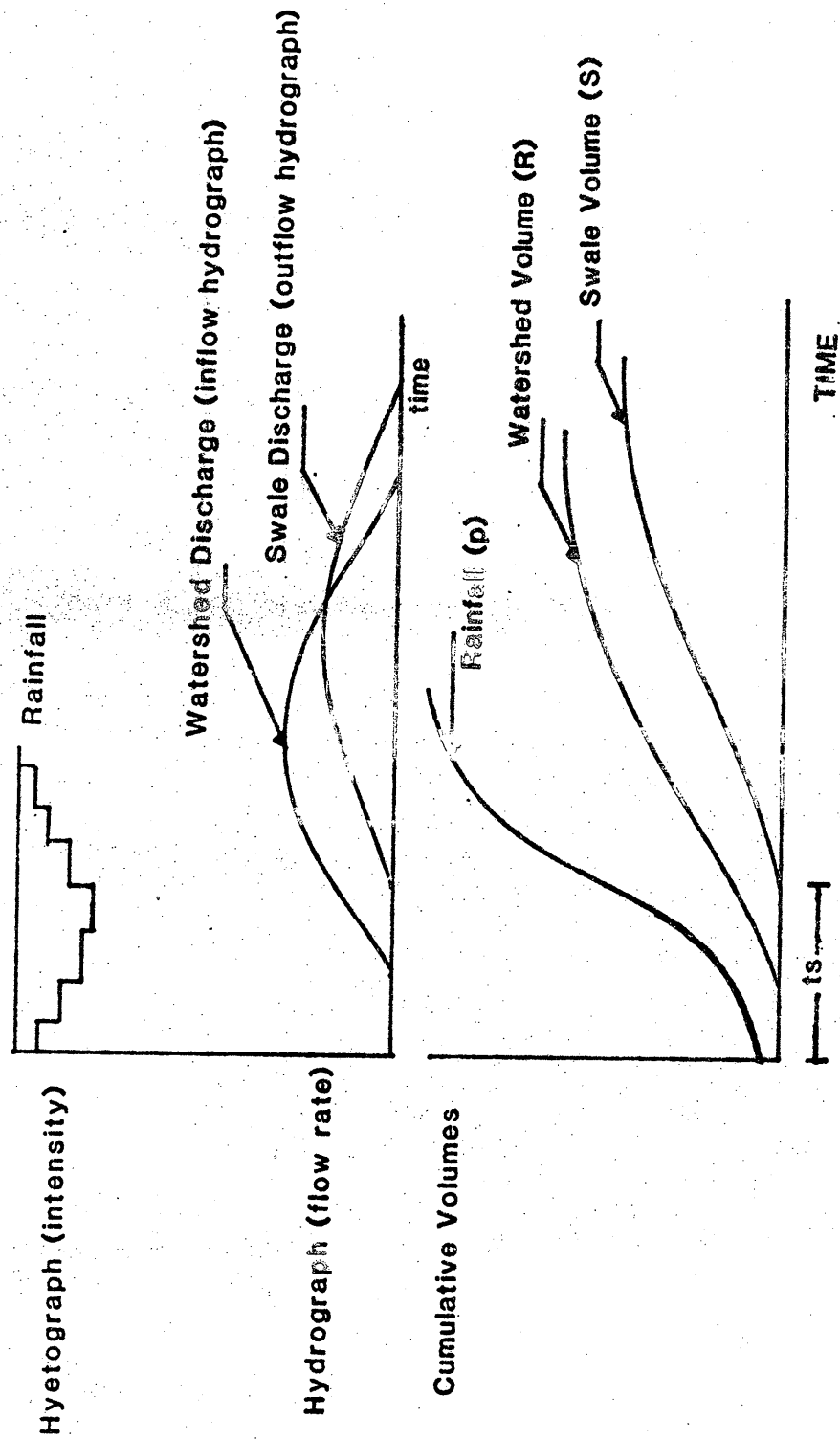

FIGURE 2 SCHEMATIC DIAGRAMS FOR HYDRAULIC DESIGN OF SWALES

The runoff coefficient can be estimated from past studies, hydraulically connected area, or from published data. It should be recognized that it is variable and prudent conservative estimates are usually done. Since a swale can infiltrate, a runoff coefficient exists for a swale but is site specific. It can be used to translate watershed runoff volumes (rainfall excess) into swale volume shown in equation 3.

$$S = C_v R = C_v cP \quad (3)$$

where  $S$  = swale volume (depth)  
 $C_v$  = swale volume runoff coefficient (dimensionless)

If the flow time in a swale area can be increased, then infiltration volume can be increased. However, it is not always possible to construct longer swales, provide greater infiltration areas, and milder slopes. Thus, swale blocks to provide storage within the swales should be considered.

Experiments can be designed to measure actual flow conditions in the field environment which will aid in demonstrating infiltration by means of estimating the swale runoff coefficient and Manning's roughness coefficient "n".

#### FIELD EXPERIMENTATION

Water flow over two swale areas in Central Florida was monitored. Double ring infiltrometers were used to estimate static infiltration rates. Water flow in the swales was monitored to describe the hydrographs and volume relationships shown in Figure 2. The field sites and the actual hydrograph shapes were described in Yousef et al. 1985.

During the experiments, the water depths across the area for sections every ten to twenty feet from the beginning of the swale were recorded and surveys of cross sections were made. This procedure was necessary to

estimate the average cross sectional area of the water flowing through the swale. Measurements of the inflow and outflow from the swale area and the water cross sectional areas assisted in the determination of hydraulic parameters for the study area during these experiments.

Six flow experiments were conducted using different watershed flow rates (inflow to the swale). The results are shown in Table 5. During watershed runoff to the swale, the flow from the swale was monitored to produce the shape of the swale discharge hydrograph. The rainfall excess inflow (watershed runoff) and swale outflow was calculated in depth of flow by dividing the volume measurements by the average swale wetted area. Estimates could then be made for the swale runoff coefficient.

#### RUNOFF COEFFICIENTS

Flow hydrographs were analyzed by hydrologic and hydraulic properties and the hydrograph characteristics of the swale experiments are shown in Table 5. This represents the flow data reduced to volume measurements and the swale runoff coefficients. There are two runoff coefficients noted in Table 5; one is used to calculate the runoff volume from the swale, and the other is used to calculate peak discharge (outflow) from the swale. The volume runoff coefficient is the one noted in equation 3. It is a function of the flow, moisture conditions, and detention time in the swale. Thus, variable numbers can be expected. It is however noted that the longer the duration of flow, the closer the volume runoff coefficient is to the coefficient used to estimate peak discharge. Using these runoff coefficients, swale outflow volume is estimated using equation 3 and peak discharge can be estimated using:



TABLE 5 Hydrograph Characteristics Of Swale Experiments

Experiment No.	Location	Flow Characteristics		Rainfall Excess		Swale		Swale Runoff Coefficients		Peak (C <sub>p</sub> )		
		Length (feet)	Length (m)	Duration (hr)	Inflow (inches)	Excess (cm)	Outflow (inches)	Volume (cm)	Infiltration (inches)		Volume (C <sub>v</sub> )	
1	Maitland	174	53	3.0	18.18	46.18	7.80	19.81	10.38	26.37	0.43	0.48
2	Maitland	174	53	4.0	11.32	28.75	4.56	11.58	6.76	17.17	0.40	0.46
3	Maitland	160	49	5.5	7.81	19.84	0	0	7.81	19.84	0	*
4	Maitland	174	53	4.0	14.48	36.78	3.76	9.55	10.72	27.23	0.74	0.78
5	EPCOT	295	90	4.2	17.34	44.04	11.76	29.87	5.58	14.17	0.68	0.76
6	EPCOT	295	90	4.0	14.76	37.49	9.72	24.69	5.04	12.80	0.66	0.77

\* not defined

TABLE 6 Hydraulic Characteristics Of Swale Experiments

Experiment No.	Location	Length		Slope	Rainfall Excess		Time to Peak (min)	Manning's "n"
		(feet)	(m)		(m/hr)	(in/hr)		
1	Maitland	174	53	.0075	0.154	6.06	18	.058
2	Maitland	174	53	.0075	0.072	2.83	30	.086
3	Maitland	174	53	.0075	0.092	3.62	20	.049
4	EPCOT	295	90	.0034	0.105	4.13	25	.031
5	EPCOT	295	90	.0034	0.094	3.69	30	.038

$$Q_o = C_p Q_I \quad (3)$$

where  $Q_o$  = outflow hydrograph peak (L<sup>3</sup>/T)  
 $C_p$  = peak runoff coefficient for swale (dimensionless)  
 $Q_I$  = inflow hydrograph peak (L<sup>3</sup>/T)

The peak discharge equation can be used when steady state conditions are achieved.

#### ROUGHNESS COEFFICIENT

If the Manning equation is used to estimate steady state flow discharge, the choice of the roughness coefficient is needed. Published data gives some indication of a value and the field data collected and reported here also can be used to estimate a value for the roughness coefficient (n). Using the Manning equation:

$$V = K/n r^{2/3} S^{1/2} \quad (4)$$

where	K = constant,	English	Metric
	V = flow velocity (L/T),	1.486	1.0
	r = hydraulic radius (L),	ft/sec	m/sec
	S = slope along the flow line (L/L),	ft	m
	n = roughness coefficient,	ft/ft	m/m
		(dimensionless)	

and assuming the width of flow to be much greater than the depth of flow (overland flow) and rainfall excess is equivalent to depth of flow per unit time, then the Manning coefficient can be estimated using the equation developed by Wanielista et al. (1983):

$$n = (t_e^{5/3} S^{1/2} (R/t)^{2/3})/L \quad (5)$$

where  $R/t$  = Rainfall excess rate (m/hr)  
 $t_e$  = time to equilibrium, (min)  
 $L^e$  = length of swale (m)

Table 6 illustrates the results with other hydraulic characteristic data. The Manning roughness coefficient is lowest for the EPCOT site most likely because there was new vegetation on the site and thus relatively lower resistance. The vegetation at the Maitland site was more dense and well

established. The cover grass is bahia with height varying between 2-6 inches during the entire experimentation period. The average Manning coefficient (n) was about 0.050.

#### SWALE BLOCKS

The rainfall excess volume from the 3" storm at the Maitland Interchange would be approximately 100 cubic feet (2.8 cubic meters) and about 2500 cubic feet (70.8 cubic meters) at the EPCOT Interchange. Infiltration of this volume of water by the swale would at best be about 60% ( $1 - 0.40$ ) except for that storm similar to the third experiment. Of course, low rainfall intensities would allow greater runoff water volumes to infiltrate such as in experiment three as shown in Table 5. Thus, from the field experimentation, it is not probable that these swales can infiltrate the inflow waters from a 3 inch (7.6 cm) rainfall event. Very long swales with long detention times and high infiltration rates would be required. Swale blocks to provide storage of that rainfall excess not removed by infiltration through the swale must be designed for this situation.

Rehmann-Koo (1984) developed swale block spacing for the runoff from an interstate highway system. The runoff volumes were from one and three inch storms and the calculated required swale block storage for two types of soil are shown in Table 7. For this swale block spacing analysis, two infiltration rates were considered. The high infiltration rate watershed had a rate (limiting of 1 in/hr, 2.54 cm/hr) similar to "A" type SCS hydrologic classified soils while the low infiltration rate watershed had a much lower rate (about 0.1 in/hr, 0.254 cm/hr).

TABLE 7 Required Storage Volume for Two Watershed Infiltration Rates Using a 1" and 3" Volume of Rainfall

Watershed	Volume of excess/foot of highway (ft <sup>3</sup> <u>1" of rainfall</u> )	volume/ ft highway)* <u>3" of rainfall</u>
Impervious (no infiltration)	8.33	25.0
Infiltration Rate (0.1 "/hr)	7.60	22.8
Infiltration Rate (1"/hr)	3.80	11.4

\*Adopted from Rehmann-Koo (1984)

Since a swale block will produce a pool of water similar in shape to a frustum, the required storage area and geometry can be calculated for various cross sections and slopes of swales. All the as-built swale and ditch cross sections that were measured at the Maitland and EPCOT Interchanges can be approximated more easily by a triangular section. However, they were most likely designed as a trapezoidal section. For the analysis of an operational highway, it is expected that grass cutting equipment and normal slope deterioration will reduce the trapezoidal section to one approximating a bowl or triangular shape. For analysis of swale blocks, the triangular shape is assumed. Typically the Florida Department of Transportation (FDOT) uses a trapezoidal ditch rather than a triangle as shown. The trapezoidal shape provides more soil contact area for infiltration. Thus, the trapezoidal shape is preferred for infiltration. For a trapezoidal shaped swale, the swale block geometry can be estimated using Equation 6.

$$V = 1/6 L (A_0 + 4A_1 + A_2) \quad (6)$$

$$V = 1/6 L \{0 + 4[1/2(a + b/2)H/2] + [1/2(a + b)H]\}$$

where

- L = total length, (ft) (m)
- $A_0$  = Volume at end of swale, (ft<sup>3</sup>) (m<sup>3</sup>)
- $A_2$  = Cross-sectional area at berm, (ft<sup>2</sup>) (m<sup>2</sup>)
- $A_1$  = Cross-sectional area at half the length, (ft<sup>2</sup>) (m<sup>2</sup>)
- a = Width of the bottom of the swale, (ft) (m)
- b = Width of swale water line at berm, (ft) (m)
- H = Maximum depth at center line of swale at berm, (ft) (m)

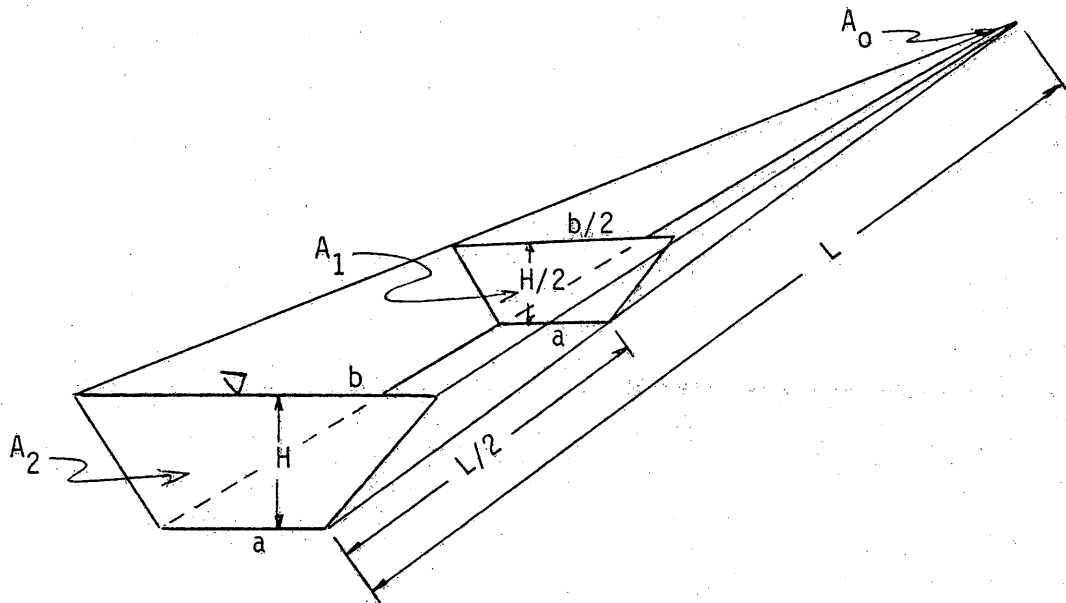

Swale Isometric

For a 6:1 side slope and various longitudinal slopes, Rehmann-Koo (1984) developed a berm spacing chart as shown in Figure 3. Similar charts can be developed for other sets of assumptions on rainfall storms and watershed characteristics. Since there is a variety of watershed conditions, each area of highway must be examined separately.

#### EXAMPLE PROBLEM

Using the data generated from the research reported in the previous sections, an evaluation procedure is illustrated using similar soil and water table conditions. This is done to determine if it is feasible to

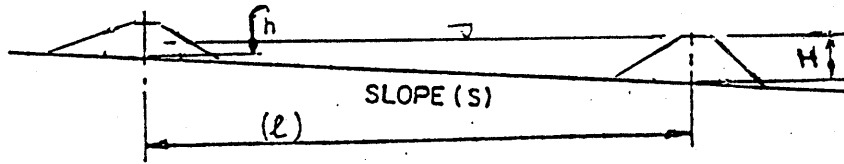

$H=1.75'$ ,  $h=0.50'$  TYPE A-6  
 $(H=2.0', h=0.75')$  TYPE B-6

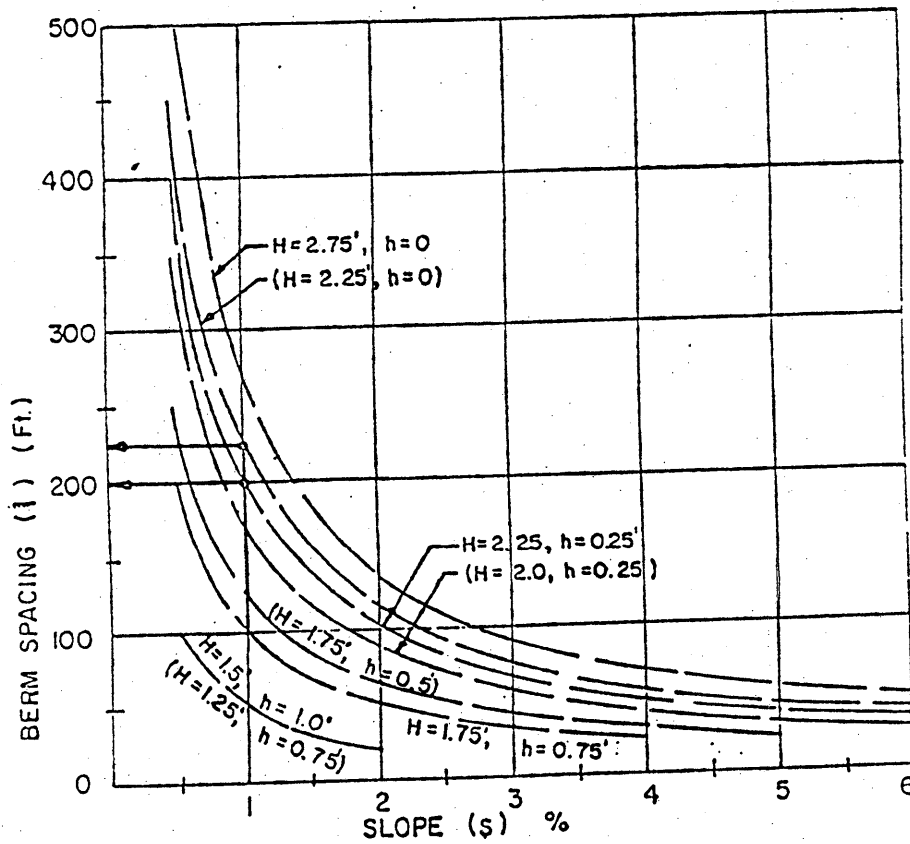

Figure 3 Berm Spacing ( $l$ ) as a Function of Berm Heights ( $H, h$ ) and Slope ( $s$ ) for Swale of Side Slope of 6 on 1

(from Rehmann-Koo, 1984)

construct a swale block for an operational highway. Three inches (7.6 cm) of rainfall is used. The watershed area is one acre with a typical watershed runoff coefficient of 0.4. The designer must determine the runoff coefficient value based on actual conditions (Florida Department of Transportation, 1986). These values will vary with the interstate or other highway under investigation. The runoff volume is:

$$R = (0.4)(3")(43,560 \text{ ft}^2/\text{ac})(1 \text{ ac})(1'/12")$$

$$R = 4356 \text{ cubic feet (123 cubic meters)}$$

Using a swale volumetric runoff coefficient, ( $C_v$ ) of 0.70, a length of swale equal to 500 feet (152 meters), and a cross sectional side slope of 1 on 6, the following calculations for a swale block design results. The runoff coefficient most likely would be lesser for a 500 foot (152 m) length at the Maitland and EPCOT sites. The width of highway at the Maitland site (watershed width) including the swale area is about 90 feet (37 meters). The hydraulic slope of the swale bottom over the 500 feet (152 m) averages .002.

Swale Volume:

$$S = C_v R$$

$$= 0.7(4,356) = 3049 \text{ ft}^3 (86.4 \text{ m}^3)$$

Swale Block Design Height:

To store 3049 cubic feet (in a triangular section)

$$S = (L/3)(A + a + Aa) \quad (7)$$

$$= 500/3 (WH/2 + wh/2 + (WH/2)(wh/2))$$

$$\text{and } W = 12H, w = 12h, h = H - .002(500)$$

substituting and solving

$$H = 1.5 \text{ feet (45 cm)}$$

$$\text{and } h = 0.5 \text{ feet (15 cm) (approximately)}$$

A swale block height of 1.5 feet (45 cm) using a (10 to 1) flow line swale block slope is considered reasonable from a safety and maintenance viewpoint.

If a trapezoidal section with a six foot base were used, the height of the swale block would be 0.8 feet (0.25 m). If the section after construction would remain more trapezoidal, then a lesser height of swale block would be necessary.

Similarly constructed swale blocks on the campus of the University of Central Florida and in Orange County, Florida have had no maintenance problems over a 2 year period of time. Grass cutting has not been a problem.

#### SUMMARY

Swales are grassy waterways in soils that will infiltrate rainfall excess. With significant infiltration, peak discharges and rainfall excess volume will be reduced. Two field sites were carefully instrumented to document runoff and infiltration. With these data, estimates were made of runoff coefficients that illustrate the effectiveness of the swale to reduce runoff volumes and peak flow rates. Also estimates were obtained for the roughness coefficient of the swales studied. Average runoff coefficients will vary from site to site. An average roughness coefficient of 0.05 is suggested for use in similar systems.

Swale blocks can be used to further retain water for infiltration. Essentially, the geometry of the swale and rainfall excess determine the size of swale blocks and their spacing.

This research should be demonstrated using other field sites to document infiltration rates and to generate site-specific efficiencies and design criteria based on infiltration rates, geometry, hydraulic, and hydrologic data.



## CHAPTER IV

### SWALE BLOCK PERFORMANCE

#### INTRODUCTION

A site adjacent to a four lane highway located on the campus of the University of Central Florida was selected to determine the efficiency of a swale block system. The site was chosen because of its well documented soil and watershed sizes, and because of its proximity for constant investigations. Details for the swale block design are outlined in this Chapter. During rainfall events, runoff volume and solids concentrations were obtained from field instrument and laboratory analysis. The time span for sediment data collection was from July through October 1983, the typical wet season in the area. Continued observation of the volume retained has proceeded for an additional 2 years.

#### DESCRIPTION OF SWALE SYSTEM

The swale system studied collects runoff from a watershed area of approximately fourteen acres. The watershed is divided into two major subwatersheds with approximately 5 acres located to the south and approximately 9 acres situated to the north of University Boulevard as shown in Figure 4. The swale blocks and sampling site locations are shown in Figure 4 and details for the swale block construction in Figure 5. Swale block (A) was constructed in July 1983 and washed out after three consecutive storms. Swale block (A) was not designed to store runoff from a 3 inch (7.6 cm) storm nor was overflow considered. It was not covered with sod and its flow-line slopes were one-to-one. It was built to examine structural design integrity. Swale blocks (B), (C), and (D) were built to

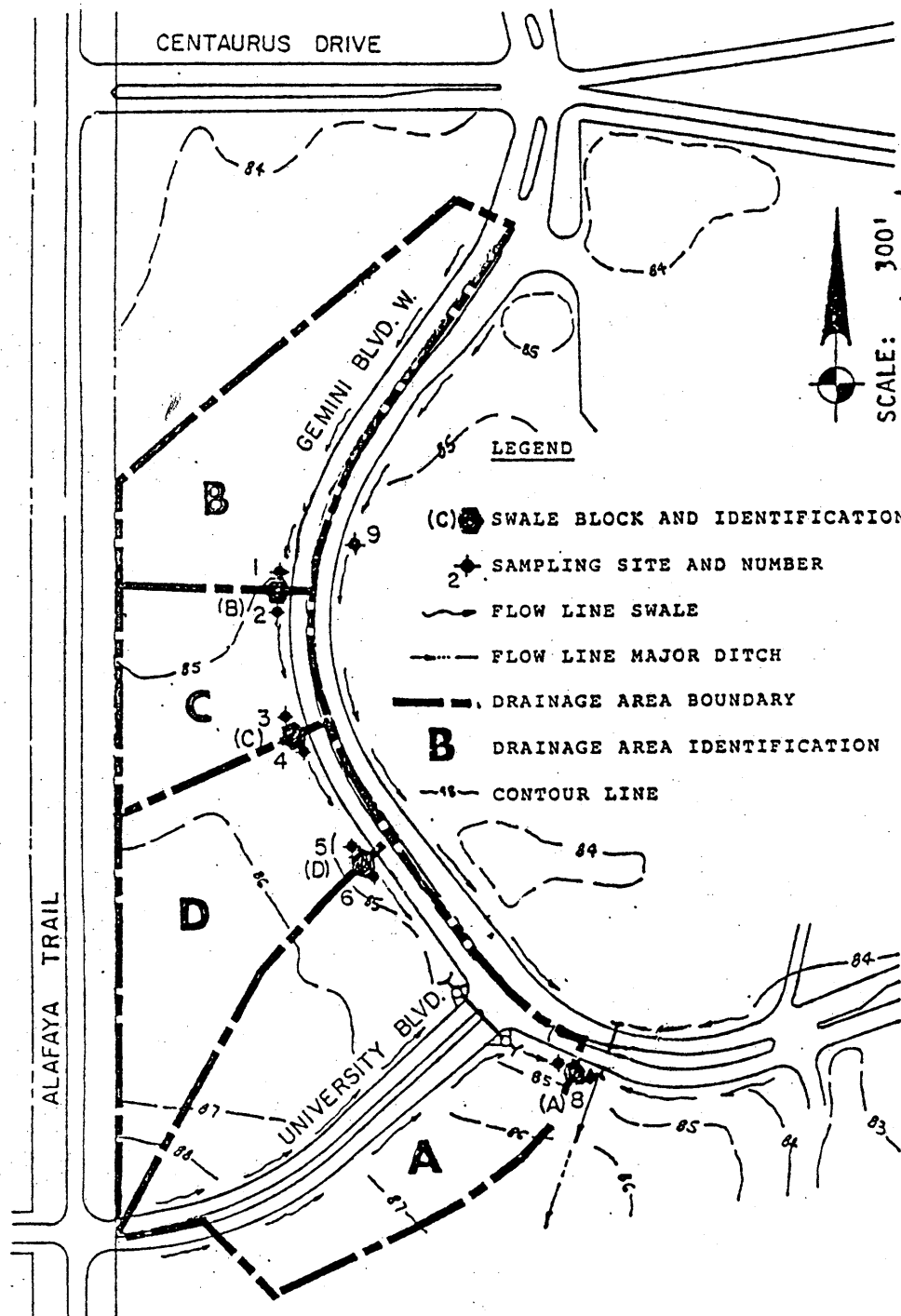
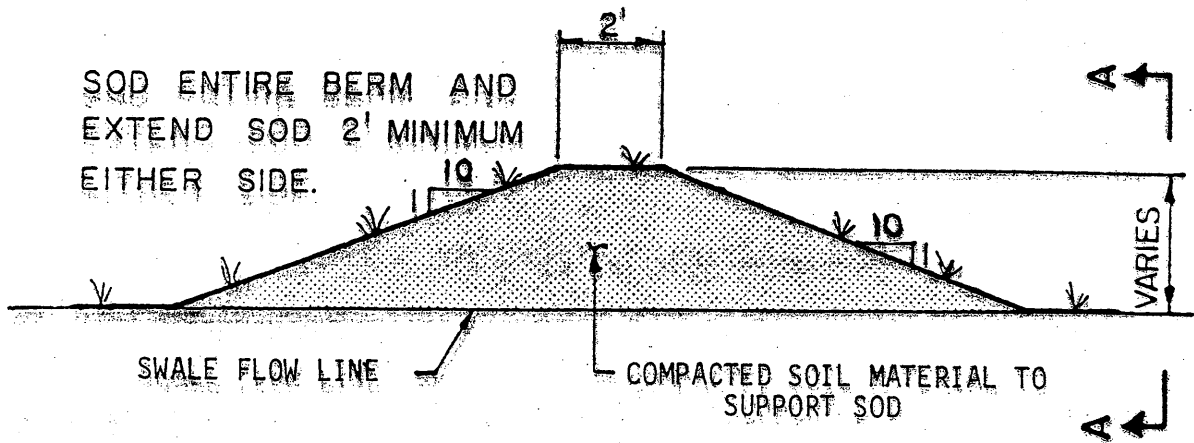
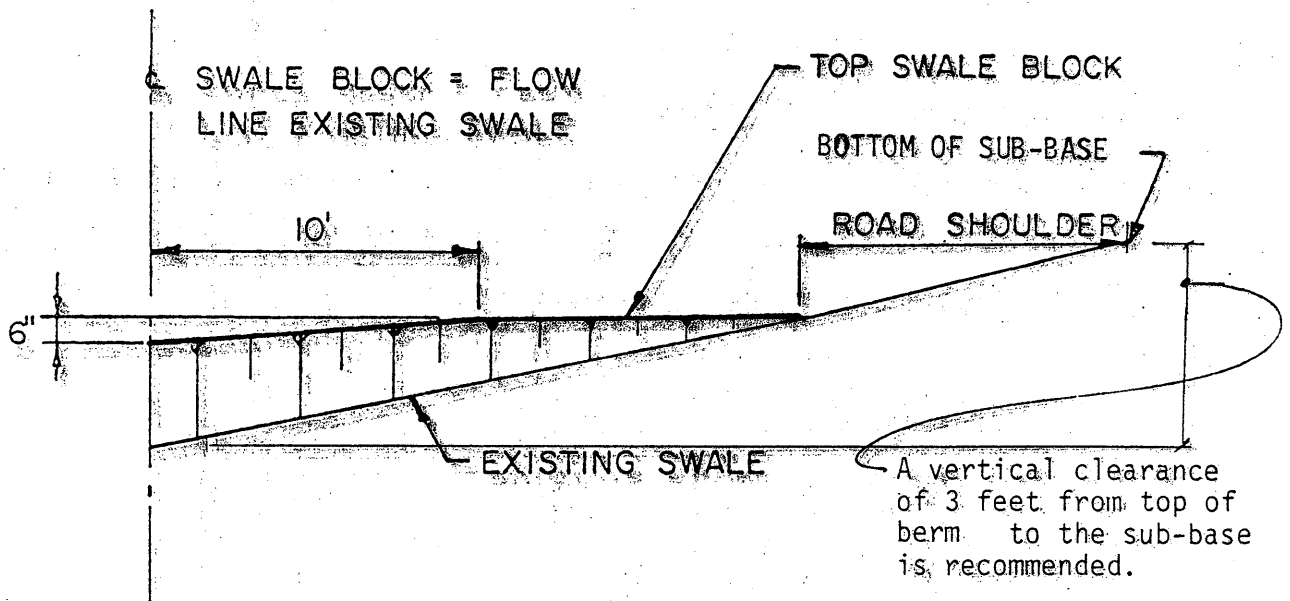

Figure 4 SITE PLAN



### TYPICAL SWALE BLOCK CROSS SECTION

Not to Scale



VIEW A-A

Not to Scale

Figure 5 SWALE BLOCK DETAILS

demonstrate proper design and operation. Berms (B), (C), and (D) were constructed with a clayey sand and mechanically compacted having flow-line slopes of six-to-one. The blocks were covered with sod extending two feet either side along the berm toe. The swale blocks still exist 2 years after their construction. Wash-out has not occurred. It is important to keep the height of the swale block above the swale bottom to a minimum to insure that any ponded water does not interact to degrade pavement sub-base materials or produce unsafe conditions. The elevation difference between the bottom of the sub-base materials and the top of the berm is suggested to be at least 3 feet (91 centimeters).

#### DESIGN OF THE EXAMPLE SWALE SYSTEMS

Parameters of interest to design a swale block are: watershed area, ground cover, type of soil, water table conditions and design rainfall volume. The same design procedures as outlined in Chapter III were employed for design.

The total watershed area as well as the subwatersheds are delineated in Figure 4. The subwatershed areas were delineated from approximate location for the swale blocks. The average slope of the drainage area is about 0.3 percent and runs in an easterly to southeasterly direction. Table 8 lists the individual areas for each subwatershed.

TABLE 8 Subwatershed Areas

Drainage Area	Size	
	(acres)	(hectares)
A	5.4	2.2
B	3.1	1.3
C	1.9	0.8
D	3.3	1.3
Total	13.7	5.6

The site was inspected physically and compared with an aerial photograph flown in 1981. The three major land uses are (1) roadways, (2) grassed land with some sandy areas and (3) pine trees in sandy soils. A breakdown of the various land uses for each subwatershed is shown in Table 9.

TABLE 9 Land Use For Each Subwatershed

Land Cover	Subwatershed A			B			C			D		
	ac	ha	%	ac	ha	%	ac	ha	%	ac	ha	%
Impervious	0.95	0.38	18	0.33	0.13	11	0.11	0.04	6	0.11	0.04	3
Grass (70% Cover)	1.05	0.43	19	0.87	0.35	28	0.49	0.20	26	0.59	0.24	18
Pine Trees	3.40	1.38	63	1.90	0.77	61	1.30	0.53	68	2.60	1.05	79
Total	5.40	2.19	100	3.10	1.26	100	1.90	0.77	100	3.30	1.34	100

For the study area the Orange County Soil Survey indicates a combination of Blanton, Leon, St. Lucie and Pomello fine sand. Table 10 lists the approximate percentage of each soil type.

TABLE 10 SCS Soil Classification And Percentage Of Each Soil Type

Type of Sand	%	SCS Hydraulic Soil Classification
Blanton Fine	20	A
Leon Fine	10	A/D
St. Lucie Fine	60	A
Pomello Fine	10	C

From Table 10 the composite SCS soil classification indicates a well drained soil. From field observation to detect the water table and soil moisture, it was noted that the water table was deeper than one foot

(30.5 cm) during the wet season. The soils are well drained with high percolation rates. A double-ring infiltrometer estimates a minimum rate of 10-12 inches/hour (25-30.5 cm/hr).

#### Swale Block (A)

The design parameters for Swale Block (A) are listed as:

Watershed Area:	A = 5.4 ac (2.19 ha)
Impervious Fraction:	I = 0.18
Precipitation:	P = 3 inches (7.6 cm)
Infiltration:	Expected
Swale Cross Section:	6 horizontal to 1 vertical
Swale Slope:	S = 0.3%
Pervious Area Runoff:	PR = 0.15 inches (0.38 cm)

The runoff volume from this drainage area is calculated following standard procedures for estimation. A swale discharge coefficient of 0.7 is used.

$$\begin{aligned}\text{Total Runoff} &= \text{Impervious Area Runoff} + \text{Pervious Area Runoff} \\ &= I(A)(P)(12"/\text{ft}) + (1 - I)(A)(PR)(12"/\text{ft}) \\ &= .18(5.4)(3)(12)^{-1} + .82(5.4)(.15)(12)^{-1} \\ &= .30 \text{ ac-ft or } 13068 \text{ ft}^3 \text{ (370 m}^3\text{)}\end{aligned}$$

The berm height of swale block (A) is 2 feet (0.61 meters). For a 0.3 percent swale slope, the detained volume upstream of swale block (A) was calculated using equation 7 as 5333 ft<sup>3</sup> (151 m<sup>3</sup>). The available volume is much less than the required volume. However, the swale block was built and as expected it failed after three storms in a six day period of time with volume equal to about 1.20, 0.46, and 2.21 inches (30.5, 11.7, and 56.2 mm) respectively.

#### Swale Block (B), (C) and (D)

The design parameters are the same as stated for swale block (A) except the swale slope is 0.1%. The results for the available and required storage volumes for one foot high swale blocks are listed in Table 11. From this table it can be noted that the available storage volume is less

than the required runoff volume for the pervious and impervious portion of the watershed area. Because of the mild slopes to the west of the swale and soils with high percolation capability, one foot high swale blocks were chosen for swale blocks (B), (C) and (D). It was assumed that only the runoff from the impervious areas would reach the swale and the runoff from the pervious areas would percolate into the ground. Some of the watershed area does not contribute runoff because depressions exist in the watershed.

TABLE 11 Storage Volumes For Swale Blocks (B), (C) AND (D)

Swale Block	Watershed Area		Impervious Portion		Runoff Volume		Available Storage*	
	(ac)	(ha)	(ac)	(ha)	(ft <sup>3</sup> )	(m <sup>3</sup> )	(ft <sup>3</sup> )	(m <sup>3</sup> )
(B)	3.10	1.26	0.33	0.13	3594	102	2920	83
(C)	1.90	0.77	0.11	0.05	1198	34	976	28
(D)	3.30	1.34	0.11	0.05	1198	34	975	28

\*Storage volume for 1' high swale blocks

#### FIELD DATA

The data collected at the study site during storm events were rainfall, volume runoff and suspended solids. Runoff water samples were collected at each sampling site as indicated in Figure 4. Two 500 milliliter samples were collected at each site and analyzed for suspended solids in the laboratory immediately after collection. The methods employed in collection of the field data are described in the following section.

#### Rainfall Volume

Because of the localized storms, which are characteristic of the Central Florida area, two rain gages were placed within the watershed; one was located near swale block (B) and the other in the vicinity of swale

block (D). Rainfall is recorded daily at the University's Wastewater Treatment Plant, located approximately one half mile southwest of the study site.

It has been observed that storms of about 1.5 inches (3.8 cm) correlate very well with rainfall data from the gage located one-half mile from the berms, but smaller storms were more localized and would sometimes not register at one or the other gaging station.

#### Runoff Volume and Suspended Solids

To measure the collected volume between the swale blocks (B), (C) and (D) stakes were placed along the swale flow line at twenty foot intervals. The stakes were permanently marked at 0.5 inch (1.3 cm) intervals and the cross-sectional areas were determined for the corresponding heights. To calculate the volume of runoff, the depths were measured at each marker and the corresponding areas calculated for each reading. The volume between the markers was then calculated with an equation for a triangular section.

The topography of the area suggests that nearly all the runoff in the swales originates from the roadways, partly because the slopes of the impervious surfaces are several times steeper than the gentle slopes of the pervious areas. Runoff volumes were recorded in the swales and suspended solids levels recorded for the waters in the swales. Sampling was done to record the solids levels in the water only and not in the bed load. The sampling site locations 1 through 9 are shown in the Site Plan, Figure 4, which corresponds to the sampling location numbers and swale block identifications in Table 12 and 13. Table 12 reports on the runoff volumes after the storm events and Table 13 reports the suspended solids levels.

During the storm events of summer and fall 1983, no runoff over the swale blocks (B), (C) or (D) was observed. Water depths of zero to nine



inches maximum were recorded. If rainfall events occurred with only a one to two day recurrence interval, the stormwater in the swales was unable to percolate completely before the next storm event. For storms with a longer recurrence interval (several days or weeks) the swales would dry out within a one to two day period. The greatest rainfall observed was 2.35 inches.

TABLE 12 Runoff Volume Between Swale Blocks\*

1983 Dates	Rainfall in cm		Runoff Volume Between Swale Blocks								Remarks
			Up Stream of (B) <sub>3</sub>		Up Stream of (C) <sub>3</sub>		Up Stream of (D) <sub>3</sub>		Down Stream of (D) <sub>3</sub>		
			ft <sup>3</sup>	m <sup>3</sup>	ft <sup>3</sup>	m <sup>3</sup>	ft <sup>3</sup>	m <sup>3</sup>	ft <sup>3</sup>	m <sup>3</sup>	
9/03	0.70	1.78	330	9.4	230	6.5	200	5.7	200	5.7	Erosion evident near swale block D
9/19	1.55	3.94	200	5.7	370	10.5	420	11.9	630	17.9	
9/20	0.30	0.76	0	0	0	0	230	6.5	300	8.5	
9/21	0.50	1.27	130	3.7	220	6.7	420	11.9	500	14.2	On 9/22 standing water of several inches was observed between swale blocks
10/11	1.30	3.30	0	0	0	0	0	0	0	0	(B), (C) and (D)
10/17	2.35	5.97	200	5.7	270	7.7	330	9.4	240	6.8	

\*approximately one hour after every storm event

TABLE 13 Rainfall (Inches) And Average Total Suspended Solids Concentrations (mg/L) For Various Storm Events

Date	Rainfall (inches) (cm)		Suspended Solids at sample site (mg/L)									
			(1)	(2)	(3)	(4)	(5)	(6)	(7)	(8)	(9)	
7/27/83	0.41	1.04	*	*	*	*	*	*	*	34	21	*
9/03/83	0.70	1.78	21	26	41	45	443	204	71	41	*	
9/19/83	1.55	3.94	4	18	6	17	230	220	136	34	*	
9/20/83	0.30	0.76	3	2	6	*	*	*	54	*	2	
9/21/83	0.50	1.27	3	9	10	47	187	539	23	6	5	
10/11/83	1.30	3.30	*	*	*	*	*	*	248	48	47	
10/17/83	2.35	5.97	40	33	31	38	108	372	114	36	47	

\*Missing data because water depth insufficient to sample

The swale blocks were designed to infiltrate the runoff volume from a 3 inch (7.6 cm) storm event during and after a rainfall event. Apparently, the swale blocks did function to retain the runoff waters. Three storms greater than 3 inches (7.6 cm) have been recorded in the past 2 years. The swale blocks did not wash away and are still functioning to retain and infiltrate stormwater.

Sampling sites 5 and 6 had the highest solids concentrations for all storm events. Inspection of the ground cover showed that areas on both sides of the swale in the vicinity of swale block (D) were nearly bare, with little vegetative ground cover. During storms, rill erosion took place leaving rills with depths of 1-4 inches (3-10 centimeters). It is concluded that the high suspended solids concentrations at sampling site 5 and 6 are a result of erosion from the bare areas.

For sampling site 1 through 4, the total solids concentrations vary from 2 to 47 mg/L. The water at these locations was observed to have brownish tint, which could be due to degradation of vegetation or oils. The ground cover of the watershed for sampling sites 1 through 4 is uniformly vegetated with approximately 70 percent cover and minor bare spots.

It was also observed that a large portion of the suspended solids had a specific gravity of close to one and were floating on the water. After the water had percolated into the ground a black layer could be observed which would indicate organic deposits. The black color disappeared after a few days, indicating that bacteria could have decomposed the organic deposits.

## SUMMARY

Swale blocks were constructed using the evaluation procedures of Chapter 3. Field tests were conducted on retained volume and solids. The field results indicate that swale blocks can be effective for suspended solids retention and runoff volume reduction. The suspended solids concentrations in the runoff were found to relate to the type of ground cover in the watershed basin. The swale blocks continue to operate effectively after a 2 year period of time.

CHAPTER V  
SUMMARY, CONCLUSIONS AND RECOMMENDATIONS

Erosion and sediment transport are possible problems in the operation of highways. Erosion of shoulder areas can alter the structural integrity of the pavement, cause localized flooding and provide sediment which in turn can reduce hydraulic capacity of drainage structures. In addition, sediment can be a primary cause of off-site pollution problems. It would be very helpful to highway designers and maintenance crews to identify the effectiveness of erosion control practices and methods for sediment retention.

Erosion control can be most effectively accomplished using sod or other permanent vegetative cover. Effectiveness is measured by the quantity of sediment retained. Experiences at a field test site showed that those areas that were not sodded experienced erosion and those that had a permanent cover had less erosion with lower sediment loads. Other methods of erosion control were identified from the literature and compared to sodding. Sodding was found to be the most effective method.

Sediment control of stormwater discharges is primarily done using off-line retention (diversion) and detention ponds. Their solids retention effectiveness has been defined and related to design criteria. Swales have not been quantified as to their retention efficiencies. Swales are grassy waterways that transport and infiltrate runoff waters. With significant infiltration, peak discharges and runoff volume will be reduced. Runoff coefficients for two swale areas adjacent to an interstate highway were estimated. A maximum value of 0.74 was noted in six experiments. Also, the roughness coefficient in the Manning equation was estimated as 0.05.

This runoff coefficient and roughness coefficient are appropriate for the length, slope, and vegetative covers in the experimental area. Thus, the values are site specific.

It is highly unlikely that a swale can be designed to retain most runoff waters. Longitudinal and side slopes would have to be, in general, very minimal and the swale very long. However, earthen cross barriers or swale blocks can be used to increase retention. A procedure for swale block design was developed. Three swale blocks were constructed to illustrate operational effectiveness. The blocks were designed to retain the runoff from a 3 inch (7.6 cm) storm event. After more than two years of operation and three storms of over 3 inches (7.6 cm), the retained water has not been known to overflow the block. Thus it is possible that swales and swale blocks within highway right-of-ways can be designed and operated to be as effective in the retention of solids as retention and detention systems.

To retain solids within an operating highway system, the following recommendations are made.

1. Permanent vegetative covers are used to reduce erosion. Other erosion control methods should be considered if their effectiveness is equal to or greater than permanent vegetative covers. However, the use of non pervious erosion control will defeat the infiltration concept in the swale.
2. Sediment can be retained using off-line retention, on-line retention, detention systems, and swale blocks.
3. Swale blocks should be designed using the methodologies of this report. The volume of runoff for each design should incorporate an estimate of infiltration volume.

4. Swale block design must consider at least a 3 feet (91 cm) clearance between the top of a swale block and the bottom of sub-base materials and not present a safety hazard. The beam flow line slopes should be about 1 vertical to 10 horizontal. The maximum height is about 1 1/2 feet.
5. Additional data on infiltration rates, runoff coefficients and roughness coefficients should be obtained for other swales and swale blocks adjacent to highways. This will aid in determining a general design procedure.

## REFERENCES

- Agricultural Research Service. "A Universal Equation for Predicting Rainfall-Erosion Losses." ARA, 22-66, 1961.
- American Public Works Association. Water Pollution Aspects of Urban Runoff. Federal Water Pollution Control Association Research Series WP-20-15, January 1969.
- Anderson, David E. "Evaluation of Swale Design." Master's Thesis, University of Central Florida, Orlando, 1982.
- Barnett, A.P.; Diseker, Ellis G.; and Richardson, E.C. "Evaluation of Mulching Methods for Erosion Control on Newly Prepared and Seeded Highway Backslopes." Agronomy Journal 59 (January-February 1967): 529-538.
- Busey, Philip. Breeding of Better Roadside Grasses, FDOT Project 99700-7180-010. State Department of Transportation Quarterly Report, October 1 to December 31, 1977.
- Cullum, M.G. "Stormwater Runoff Analysis at a Single Family Residential Site" in Stormwater Management: An Update, edited by M.P. Wanielista, Publication 85-1, University of Central Florida, July 1985.
- Diseker, Ellis G. and McGinnis, John T. "Evaluation of Climatic, Slope and Site Factors on Erosion from Unprotected Roadbanks." Transactions of the ASAE, 10, January 1967.
- Diseker, Ellis G. and Richardson, E.C. "Erosion Rates and Control Methods on Highway Cuts." Transactions of the ASAE, 5, February 1961: 153-155.
- East Central Florida Regional Planning Council. "Best Management Practices, Stormwater Management Report." 208 Areawide Water Quality Management Planning Program. Winter Park, Florida, August 1983.
- Ellis, J.B. and Revitt, M.D. "Incidence of Heavy Metals in Street Surface Sediments: Solubility and Grain Size Studied." Water, Air and Soil Pollution, 17, January 1982: 87-100.
- Ellis, J.B. "Sediment and Water Quality of Urban Stormwater." Water Sciences, 80, 1977: 730-734.
- Farnworth, Edward G. Impacts of Sediment and Nutrients on Biota in Surface Waters of the United States. EPA-600/3-79-105. Washington D.C.: U.S. Environmental Protection Agency, October 1979.
- Florida State Department of Transportation. Drainage Manual. Chapter 6. January 1986.
- Florida State Department of Transportation. Roadway and Traffic Design Standards. Index 105, January 1985.

- Florida State Department of Transportation. Roadway and Traffic Design Standards. Index 208, January 1985.
- Florida State Department of Transportation. Standard Specification for Road and Bridge Construction, Section 162-2, "Muck Blanket and Top Soil Materials", 1982.
- Gupta, M.K.; Agnew, R.W.; and Kobriger, N.P. Constituents of Highway Runoff. Vol. I: State-of-the-Art Report. Report No. RHWA/RD-81/042, prepared by Envirex, Inc. for the Federal Highway Administration, Office of Research and Development, Environmental Division, Washington, D.C., February 1981.
- Gupta, M.K. Constituents of Highway Runoff. Vol. IV: Constituents of Highway Runoff. Report No. FHWA/RD-81/045, Federal Highway Administration, Washington, D.C., February 1981.
- Haith, Douglas A. and Loehr, Raymond C. Effectiveness of Soil and Water Conservation Practices for Pollution Control. EPA-600/3-79-106, Washington, D.C.; U.S. Environmental Protection Agency, October 1979.
- Harper, H.H.; Wanielista, M.P.; Yousef, Y.A.; and DiDomenico, D. "Lake Eola Restoration: Water Quality Background and Stormwater Management Practices." Orlando, FL: University of Central Florida, College of Engineering, 1982.
- Harrop, Owen. Urban Stormwater Pollution. Research Report No. 6: Stormwater Pollution from Highway Surfaces: A Review. London: Middlesex Polytechnic Research and Consultancy, February 1983.
- Hickok, E.A. and Associates. "Wetlands and Organic Soils for the Control of Urban Stormwater." Lake Restoration. Washington, D.C.: Environmental Protection Agency, 1980.
- Hoffman, A.J. Nationwide Inventory of Air Pollution Emission. National Air Pollution Control Administration, Publication No. AP-73, Raleigh, NC: USPHWE, 1970.
- Israelsen, C.E. et al. "Erosion Control During Highway Construction." National Cooperative Highway Research Program Report No. 221, April 1980.
- Jacobsen, P. and Harremoes, Paul. "Significance of Semi-Pervious Surfaces in Urban Hydrology." In Proceedings of the Second International Conference on Urban Storm Drainage, Urbana, Illinois, June 15-19, 1981. Littleton, Colorado: Water Resources Publication, 1981.
- Kent, Edward J.; Yu, Shaw Li; and Wynat, David C. "Drainage Control Through Vegetation and Soil Management." Transportation Reserach Record 896. May 1983.
- Kobriger, N.P.; Meinholz, T.L.; Gupta M.K.; and Agnew, R.W. Constituents of Highway Runoff. Vol. III: Predictive Procedure for Determining Pollution Characteristics in Highway Runoff. Report No. FHWA/RD-81/044, prepared by Envirex, Inc. for the Federal Highway Administration, Office of Research and Development, Environmental Division, Washington, D.C., February 1981.



- Minnesota Department of Highways. Erosion Prevention and Turf Establishment Manual, 1970.
- North Carolina State Highway Commission. Temporary Erosion and Pollution Measures. Raleigh, NC, 1972.
- Oliver, L.J. and Gregoropoulos, S.G. "Control of Storm-Generated Pollution Using a Small Urban Lake." Journal WPCF, Vol 53, No. 5, 1981.
- Otis, R.J. "Onsite Wastewater With Treatment Intermittent Sand Filters." In National Small Flows Clearinghouse. Morgantown, WV: University of West Virginia, 1982.
- Pitt, R.E. and Amy, G. Toxic Material - Analysis of Street Surface Contaminants. EPA-R2-73-283. Washington, D.C.: U.S. Environmental Protection Agency, August 1973.
- Rehmann-Koo, Susanna H. Highway Runoff and Sediment Control, Research Report, University of Central Florida, Orlando, 1984.
- Reinertsen, Torkild R. "Quality of Stormwater Runoff from streets." In Proceedings of the Second International Conference on Urban Storm Drainage, Urbana, Illinois, June 15-19, 1981. Littleton, Colorado: Water Resources Publications, 1981.
- Richards, Dennis L. and Middleton, Lloyd M. Best Management Practices for Erosion and Sediment Control. Department of Transportation, Federal Highway Administration, Region 15, Report No. FHWA-HD-15-1. Washington, D.C.: U.S. Government Printing Office, December 1978.
- Sartor, J.D.; Boyd, F.B.; and Agardy, F.T. "Water Pollution Aspects of Street Surface Contaminants." Journal Water Pollution Control Federation 46 (March 1972): 458-467.
- Stumm, Werner and Morgan, James J. Aquatic Chemistry, 2nd ed. New York; John Wiley and Sons, 1981.
- Sylvester R.O. and DeWolfe, F.B. Character and Significance of Highway Runoff Waters. University of Washington, Washington State Highway Department, Research Program Report 7.1, November 1971. Cited in Gupta et al., Constituents of Highway Runoff Vol. I, State-of-the-Art Report. February 1981.
- Todd, David K. Groundwater Hydrology. 2nd ed. New York: John Wiley and Sons, 1980.
- U.S. Environmental Protection Agency. Methods for Identifying and Evaluating the Nature and Extent of Nonpoint Sources of Pollutants. EPA-4030/9-73-014. Washington, D.C.: U.S. Environmental Protection Agency, October 1973.
- Walsh, T.B. and Alberga, S.R. "An Alternative For Pine Flatwoods", in Stormwater Management: An Update, 85-1 University of Central Florida, Orlando, FL, p. 201-221, July 1985.

- Wanielista, M.P. and Shannon, E. "Quality Considerations in the Design of Holding Ponds" in Stormwater Retention/Detention Basins Seminar, edited by Y. Yousef, Orlando, FL, August 1977.
- Wanielista, M.P.; Gennaro, R.; Bell, J.H.; and Johnston, J.W. "Shallow Water Roadside Ditches for Stormwater Purification." FL-ER-2-78. Tallahassee, FL: Department of Transportation, Bureau of Environment, 1978.
- Wanielista, Martin P. Stormwater Management: Quantity and Quality. Ann Arbor, Michigan: Ann Arbor Science Publishers, 1979.
- Wanielista, M.P.; Yousef, Y.A.; Harper, H.H.; and Cassagnol, C.L. "Detention with Effluent Filtration for Stormwater Management." In Proceedings of the Second International Conference on Stormwater Drainage, University of Illinois, Urbana, IL, 1982.
- Wanielista, M.P.; Yousef, Y.A.; and Harper, H.H. "Hydrology/Hydraulics of Swales." Paper presented at the Workshop on Open channels and Culvert Hydraulics, Orlando, Florida, October 22-23, 1983.
- Yousef, Y.A.; Wanielista, M.P.; Harper, H.H.; Pearce, D.B.; and Tolbert, R.D. Best Management Practices - Removal of Highway Contaminants by Roadside Swales, Florida Department of Transportation, July 1985.